



RIVMAX™

THE BOLTLESS SHELVING SYSTEM

- † **Flexible**
- † **Versatile**
- † **Expandable**
- † **Cost Competitive**
- † **ISO 9001-2000 compliant**
- † **100% durable powdercoat finish**

RIVMAX MANUFACTURING

Height up to 14 ft. - Widths to 60 inches

Depth to 48 inches

RIVMAX™ standard-duty, low profile shelving units provide economical storage of hand loaded items with completely boltless assembly. Standard duty shelving is the choice when optimizing shelf density and clear height openings.

Shelf capacities listed are based on use of 5/8 inch particle board shelf surfaces.



7S3612-6A

STANDARD DUTY SHELVING

W x D x H	Starter Unit	Wgt.	Adder Unit	Wgt.	Extra Shell	Wgt.	Shelf Cap
36 INCH WIDE UNITS							
36 x 12 x 84	7S3612-6S	49.0	7S3612-6A	44.0	S3612	3.4	450*
36 x 18 x 84	7S3618-6S	52.0	7S3618-6A	45.2	S3618	3.4	450*
36 x 24 x 84	7S3624-6S	54.0	7S3624-6A	46.2	S3624	3.4	450*
36 x 30 x 84	7S3630-6S	61.6	7S3630-6A	57.8	S3630	6.4	450*
36 x 36 x 84	7S3636-6ST	83.6	7S3636-6AT	79.8	S3636T	8.5	450*
36 x 48 x 84	7S3648-6ST	96.0	7S3648-6AT	92.2	S3648T	10.1	450*
42 INCH WIDE UNITS							
42 x 12 x 84	7S4212-6S	53.6	7S4212-6A	48.0	S4212	3.8	325*
42 x 18 x 84	7S4218-6S	56.0	7S4218-6A	49.2	S4218	3.8	325*
42 x 24 x 84	7S4224-6S	58.0	7S4224-6A	50.2	S4224	3.8	325*
42 x 30 x 84	7S4230-6S	65.6	7S4230-6A	61.8	S4230	6.8	325*
42 x 36 x 84	7S4236-6ST	87.6	7S4236-6AT	83.6	S4236T	8.9	325*
42 x 48 x 84	7S4248-6ST	100.0	7S4248-6AT	96.2	S4248T	10.5	325*
48 INCH WIDE UNITS							
48 x 12 x 84	7S4812-6S	57.6	7S4812-6A	52.0	S4812	3.4	250*
48 x 18 x 84	7S4818-6S	60.0	7S4818-6A	53.2	S4818	3.4	250*
48 x 24 x 84	7S4824-6A	62.0	7S4824-6A	54.2	S4824	4.4	250*
48 x 30 x 84	7S4830-6A	69.6	7S4830-6A	65.8	S4830	7.4	250*
48 x 36 x 84	7S4836-6ST	93.6	7S4836-6AT	89.8	S4836T	9.5	250*
48 x 48 x 84	7S4848-6ST	106.0	7S4848-6AT	102.2	S4848T	11.1	250*

MEDIUM DUTY SHELVING

Similar to Standard Duty Shelving except Heavy (12 gauge) single rivet shelves supports (SVH) are used as left to right shelf supports on intermediate shelves.

W x D x H	Starter Unit	Wgt.	Adder Unit	Wgt.	Extra Shell	Wgt.	Shelf Cap
42 INCH WIDE UNITS (36 inch wide units also available)							
42 x 12 x 84	7M4212-6S	60.8	7M4212-6A	55.2	M4212	5.6	500*
42 x 18 x 84	7M4218-6S	63.2	7M4218-6A	56.4	M4218	5.6	500*
42 x 24 x 84	7M4224-6S	65.2	7M4224-6A	50.2	M4224	5.6	500*
42 x 30 x 84	7M4230-6S	72.8	7M4230-6A	69.0	M4230	8.6	500*
42 x 36 x 84	7M4236-6ST	101.2	7M4236-6AT	97.4	M4236T	12.3	500*
42 x 48 x 84	7M4248-6ST	116.0	7M4248-6AT	112.2	M4248T	14.5	500*
48 INCH WIDE UNITS							
48 x 12 x 84	7M4812-6S	66.4	7M4812-6A	60.8	M4812	6.6	400*
48 x 18 x 84	7M4818-6S	68.8	7M4818-6A	62.0	M4818	6.6	400*
48 x 24 x 84	7M4824-6S	70.8	7M4824-6A	63.0	M4824	6.6	400*
48 x 30 x 84	7M4830-6S	78.4	7M4830-6A	74.6	M4830	9.6	400*
48 x 36 x 84	7M4836-6ST	108.8	7M4836-6AT	105.0	M4836T	13.3	400*
48 x 48 x 84	7M4848-6ST	123.6	7M4848-6AT	119.8	M4848T	15.5	400*
60 INCH WIDE UNITS							
60 x 12 x 84	7M6012-6S	74.4	7M6012-6A	68.8	M6012	7.6	300*
60 x 18 x 84	7M6018-6S	76.8	7M6018-6A	70.0	M6018	7.6	300*
60 x 24 x 84	7M6024-6A	78.8	7M6024-6A	71.0	M6024	7.6	300*
60 x 30 x 84	7M6030-6A	86.4	7M6030-6A	82.6	M6030	10.6	300*
60 x 36 x 84	7M6036-6ST	114.8	7M6036-6AT	111.0	M6036T	14.3	300*
60 x 48 x 84	7M6048-6ST	129.6	7M6048-6AT	125.8	M6048T	16.5	300*

Uniformly distributed loads. NOTE: Contact factory when unit height to depth ratio exceeds 5 to 1. Anti-tip components may be required

These units utilize standard duty uprights (SAU & STU) and a full perimeter of double rivet angles (DA) on the top and bottom shelves for unit rigidity. The intermediate shelves use single rivet (SV) shelf supports.

- Unit capacities up to 4000 lbs.
- Units up to 24 inches deep support shelves on front and rear only
- Units over 24 inches deep support shelves on all (4) four sides
- Units 36 and 48 inches include a center shelf support on each shelf
- All Standard, Medium and Heavy duty components are interchangeable
- Unit numbers with a **T** suffix have center shelf supports
- **Units over 7 ft. tall require additional front and back members for proper unit stability**
- Add 2 additional DA members per starter unit, 1 additional per adder unit

RIVMAX™ heavy duty wide span units provide economical storage of hand loaded heavy and bulky items. Units feature a completely boltless assembly with center support which drastically reduces installation time and costs. Unit capacities based on the use of 5/8 inch particle board shelf surfaces.



7H7230-4ST

BOLTLESS CENTER
SUPPORT CONNECTION

Heights to 22 feet • Width to 96 inches
Depths to 48 inches

- Starter units utilize (4) four angle uprights
- Adder units utilize (2) two tee uprights
- Completely boltless, assembles in minutes
- Vertical shelf adjustments are in 1-1/2 inch increments
- No cross bracing permits clear access from all sides of unit
- Shelves are supported on all (4) four edges
- Unit numbers with a 'T' suffix have (1) one boltless center shelf support (DAT) 84 and 96 inch units have (2) two center shelf supports (DAT)
- 'HC' units have a channel left to right for added shelf capacity
- All heavy components are compatible with standard duty components
- May be expanded into a complete catwalk or mezzanine system
- Plywood, oriented strand board, metal and wire shelf surfaces are also available
- All standard finishes are powder coated

HEAVY DUTY SHELVING

UNIT SIZE W x D x H	STARTER UNIT	ADDER UNIT	EXTRA SHELF	CAP. PER SHELF*
48 x 18 x 84	7H4818-4S	7H4818-4A	H4818	1800
	7H4818-4ST	7H4818-4AT	HT4818	2400
48 x 24 x 84	7H4824-4S	7H4824-4A	H4824	1800
	7H4824-4ST	7H4824-4AT	HT4824	2400
48 x 30 x 84	7H4830-4ST	7H4830-4AT	HT4830	2400
48 x 36 x 84	7H4836-4ST	7H4836-4AT	HT4836	2400
48 x 48 x 84	7H4848-4ST	7H4848-4AT	HT4848	2400
60 x 18 x 84	7H6018-4S	7H6018-4A	H6018	1000
	7H6018-4ST	7H6018-4AT	HT6018	1200
60 x 24 x 84	7H6024-4S	7H6024-4A	H6024	1000
	7H6024-4ST	7H6024-4AT	HT6024	1200
60 x 30 x 84	7H6030-4ST	7H6030-4AT	HT6030	1200
60 x 36 x 84	7H6036-4ST	7H6036-4AT	HT6036	1200
60 x 48 x 84	7H6048-4ST	7H6048-4AT	HT6048	1200
72 x 18 x 84	7H7218-4S	7H7218-4A	H7218	900
	7H7218-4ST	7H7218-4AT	HT7218	1000
72 x 24 x 84	7HC7218-4ST	7HC7218-4AT	HCT7218	1400
	7H7224-4S	7H7224-4A	H7224	900
72 x 30 x 84	7H7224-4ST	7H7224-4AT	HT7224	1000
	7HC7224-4ST	7HC7224-4AT	HCT7224	1400
72 x 36 x 84	7H7230-4ST	7H7230-4AT	HT7230	1000
	7HC7230-4ST	7HC7230-4AT	HCT7230	1400
72 x 48 x 84	7H7236-4ST	7H7236-4AT	HT7236	1000
	7HC7236-4ST	7HC7236-4AT	HCT7236	1400
84 x 18 x 84	7H7248-4ST	7H7248-4AT	HT7248	1000
	7HC7248-4ST	7HC7248-4AT	HCT7248	1400
84 x 18 x 84	7H8418-4ST	7H8418-4AT	HT8418	600
	7HC8418-4ST	7HC8418-4AT	HCT8418	1100
84 x 24 x 84	7H8424-4ST	7H8424-4AT	HT8424	600
	7HC8424-4ST	7HC8424-4AT	HTC8424	1100
84 x 30 x 84	7H8430-4ST	7H8430-4AT	HT8430	600
	7HC8430-4ST	7HC8430-4AT	HTC8430	1100
84 x 36 x 84	7H8436-4ST	7H8436-4AT	HT8436	600
	7HC8436-4ST	7HC8436-4AT	HTC8436	1100
84 x 48 x 84	7H8448-4ST	7H8448-4AT	HT8448	600
	7HC8448-4ST	7HC8448-4AT	HTC8448	1100
96 x 18 x 84	7H9618-4ST	7H9618-4AT	HT9618	500
	7HC9618-4ST	7HC9618-4AT	HTC9618	1000
96 x 24 x 84	7H9624-4ST	7H9624-4AT	HT9624	500
	7HC9624-4ST	7HC9624-4AT	HTC9624	1000
96 x 30 x 84	7H9630-4ST	7H9630-4AT	HT9630	500
	7HC9630-4ST	7HC9630-4AT	HTC9630	1000
96 x 36 x 84	7H9636-4ST	7H9636-4AT	HT9636	500
	7HC9636-4ST	7HC9636-4AT	HTC9636	1000
96 x 48 x 84	7H9648-4ST	7H9648-4AT	HT9648	500
	7HC9648-4ST	7HC9648-4AT	HTC9648	1000

* Uniformly Loaded

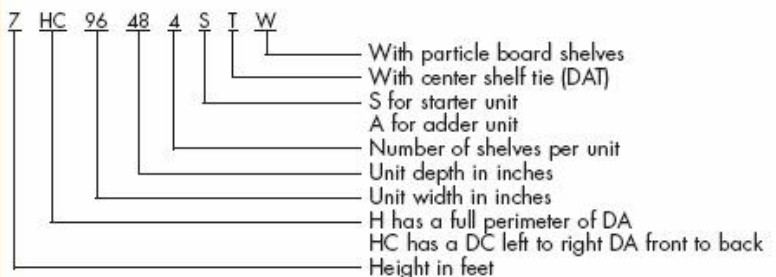

* 10000# capacity per unit

* Capacities based on static loads. Consult factory for mobile or seismic applications.

* Unit numbers listed do not include shelves. Add a suffix 'W' to unit number to include 5/8 inch particle board shelves.

RIVMAX™ record archival units are specifically designed for bulk storage of record archival boxes in order to maximize box storage while providing easy access. Unit capacities based on the use of 5/8 inch particle board shelf surfaces.



7H6930-4ST

BOLTLESS CENTER SUPPORT CONNECTION

Heights to 22 feet

Unit depths to accommodate 1, 2 & 3 boxes

Unit widths to accommodate 3, 4 & 5 boxes

- Starter units utilize (4) four angle uprights
- Adder units utilize (2) two tee uprights
- Completely boltless, assembles in minutes
- Vertical shelf adjustments are in 1-1/2 inch increments
- No cross bracing permits clear access from all sides of unit
- Shelves are supported on all (4) four edges
- Unit numbers with a 'T' suffix have (1) one boltless center shelf support
- 'HC' units have a channel left to right for added shelf capacity
- All heavy components are compatible with standard duty components
- May be expanded into a complete catwalk or mezzanine system
- Plywood, oriented strand board, metal and wire shelf surfaces are also available
- All standard finishes are powder coated
- 24 and 48 inch deep units available for banker boxes 12" w x 24" d x 10" h
- Boxes available through your RIVMAX™ distributor

RECORD ARCHIVAL STORAGE UNIT

UNIT SIZE W x D x H	STARTER UNIT	ADDER UNIT	BOX CAP	OPENINGS
UNITS (1) ONE BOX IN DEPTH				
42 x 15 x 60	5H4215-3S	5H4215-3A	18	2
56 x 15 x 60	5H5615-3S	5H5615-3A	24	
69 x 15 x 60	5H6915-3ST	5H6915-3AT	30	
42 x 15 x 84	7H4215-4S	7H4215-4A	24	3
56 x 15 x 84	7H5615-4S1	7H5615-4A	32	
69 x 15 x 84	7H6915-4S	7H6915-4A	40	
42 x 15 x 108	9H4215-5S	9H4215-5A	30	4
56 x 15 x 108	9H5615-5S	9H5615-5A	40	
69 x 15 x 108	9H6915-5ST	9H6915-5AT	50	
42 x 15 x 132	11H4215-6S	11H4215-6A	36	5
56 x 15 x 132	11H5615-6S	11H5615-6A	48	
69 x 18 x 132	11H6915-6ST	11H6915-6AT	60	
42 x 15 x 156	13H4215-7S	13H4215-7A	42	6
56 x 15 x 156	13H5615-7S	13H5615-7A	56	
69 x 15 x 156	13H6915-7ST	13H6915-7AT	70	
42 x 15 x 186	15.5H4215-8S	15.5H4215-8A	48	7
56 x 15 x 186	15.5H5615-8S	15.5H5615-8A	64	
69 x 15 x 186	15.5H6915-8ST	15.5H6915-8AT	80	

UNITS (2) TWO BOXES IN DEPTH

42 x 30 x 60	5H4230-3ST	5H4230-3AT	36	2
56 x 30 x 60	5H5630-3ST	5H5630-3AT	48	
69 x 30 x 60	5H6930-3ST	5H6930-3AT	60	
42 x 30 x 84	7H4230-4ST	7H4230-4AT	48	3
56 x 30 x 84	7H5630-4ST	7H5630-4AT	64	
69 x 30 x 84	7H6930-4ST	7H6930-4AT	80	
42 x 30 x 108	9H4230-5ST	9H4230-5AT	60	4
56 x 30 x 108	9H5630-5ST	9H5630-5AT	80	
69 x 30 x 108	9H6930-5ST	9H6930-5AT	100	
42 x 30 x 132	11H4230-6ST	11H4230-6AT	72	5
56 x 30 x 132	11H5630-6ST	11H5630-6AT	96	
69 x 30 x 132	11H6930-6ST	11H6930-6AT	120	
42 x 30 x 156	13H4230-7ST	13H4230-7AT	84	6
56 x 30 x 156	13H5630-7ST	13H5630-7AT	112	
69 x 30 x 156	13H6930-7ST	13H691530-7AT	120	
42 x 30 x 186	15.5H4230-8ST	15.5H4230-8AT	96	7
56 x 30 x 186	15.5H5630-8ST	15.5H5630-8AT	128	
69 x 30 x 186	15.5H6930-8ST	15.5H6930-8AT	160	

UNITS (3) THREE BOXES IN DEPTH

42 x 45 x 60	5H4245-3ST	5H4245-3AT	54	2
56 x 45 x 60	5H5645-3ST	5H5645-3AT	72	
69 x 45 x 60	5HC6945-3ST	5HC6945-3AT	90	
42 x 45 x 84	7H4245-4ST	7H4245-4AT	72	3
56 x 45 x 84	7H5645-4ST	7H5645-4AT	96	
69 x 45 x 84	7HC6945-4ST	7HC6945-4AT	120	
42 x 45 x 108	9H4245-5ST	9H4245-5AT	90	4
56 x 45 x 108	9H5645-5ST	9H5645-5AT	120	
69 x 45 x 108	9HC6945-5ST	9HC6945-5AT	150	
42 x 45 x 132	11H4245-6ST	11H4245-6AT	108	5
56 x 45 x 132	11H5645-6ST	11H5645-6AT	144	
69 x 45 x 132	11HC6945-6ST	11HC6945-6AT	180	
42 x 45 x 156	13H4245-7ST	13H4245-7AT	126	6
56 x 45 x 156	13H5645-7ST	13H5645-7AT	168	
42 x 45 x 186	15.5H4245-8ST	15.5H4245-8AT	144	7
56 x 45 x 186	15.5H5645-8ST	15.5H5645-8AT	192	

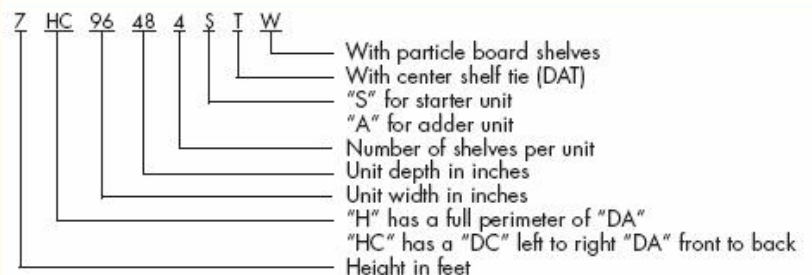

* Capacity based on maximum box weight of 50# per box and top shelf storage. Box size used 12" w x 15" d x 10" h.

* Unit numbers listed do not include shelves. Add a suffix 'W' to unit number to include 5/8 inch particle board shelves.

ONE BOX HIGH PER SHELF LEVEL

Heights up to 14ft - Widths to 56 inches - Depths to 30 inches

RIVMAX™ standard duty units provide economical storage of record archival boxes one high per shelf for easy accessibility. Units feature a completely boltless assembly. Low profile shelf supports optimize shelf density increasing the number of shelf levels vertically.

These units utilize standard duty uprights (SAU & STU) and a full perimeter of double rivet angles (DA) on the top and bottom shelves for unit rigidity. The intermediate shelves use single rivet (SV) shelf supports.

- Unit capacities up to 4000 lbs.
- One box high per shelf for maximum accessibility
- Units up to 24 inch deep support shelves on front and rear only.
- Units 30 inches deep support shelves on all (4) four sides.
- 24 inch deep units accommodate boxes 12" w x 25" d x 10-1/2" h single entry
- Designed for maximum vertical density
- Heavy duty posts can be used for heights over 14 feet or for mezzanines
- 15 and 30 inch deep units accommodate boxes 12" w x 16" d x 10-1/2" h single and double entry
- Units 56 inches wide are Medium Duty units (12ga shelf supports).

RECORD ARCHIVAL STORAGE UNIT

W x D x H	STARTER UNIT	WGT	ADDER UNIT	WGT	BOX CAPACITY	SHELVES
15 INCH DEEP UNITS (1 DEEP STANDARD 16" DEEP ARCHIVAL BOX)						
30 x 15 x 60	5S3015-5S	38.6	5S3015-5A	33.4	10	5
42 x 15 x 60	5S4215-5S	45.4	5S4215-5A	40.2	15	5
56 x 15 x 60	5SH5615-5S	59.2	5SH5615-5A	54.0	20	5
30 x 15 x 72	6S3015-6S	44.8	6S3015-6A	38.8	12	6
42 x 15 x 72	6S4215-6S	52.4	6S4215-6A	46.4	18	6
56 x 15 x 72	6SH5615-6S	69.6	6SH5615-6A	63.6	20	6
30 x 15 x 84	7S3015-7S	50.6	7S3015-7A	44.2	14	7
42 x 15 x 84	7S4215-7S	59.0	7S4215-7A	52.6	21	7
56 x 15 x 84	7SH5615-7S	79.6	7SH5615-7A	73.2	28	7
30 x 15 x 96	8S3015-8S	59.4	8S3015-8A	50.9	16	8
42 x 15 x 96	8S4215-8S	68.6	8S4215-8A	60.1	24	8
56 x 15 x 96	8SH5615-8S	92.6	8SH5615-8A	84.1	32	8
24 INCH DEEP UNITS (1 DEEP 25" DEEP BANKERS BOX)						
30 x 24 x 60	5S3024-5S	41.4	5S3024-5A	34.8	10	5
42 x 24 x 60	5S4224-5S	48.2	5S4224-5A	41.6	15	5
56 x 24 x 60	5SH5624-5S	62.0	5SH5624-5A	55.4	20	5
30 x 24 x 72	6S3024-6S	47.6	6S3024-6A	40.2	12	6
42 x 24 x 72	6S4224-6S	55.2	6S4224-6A	47.8	18	6
56 x 24 x 72	6SH5624-6S	72.4	6SH5624-6A	65.0	20	6
30 x 24 x 84	7S3024-7S	53.4	7S3024-7A	45.6	14	7
42 x 24 x 84	7S4224-7S	61.8	7S4224-7A	54.0	21	7
56 x 24 x 84	7SH5624-7S	82.4	7SH5624-7A	74.6	28	7
30 x 24 x 96	8S3024-8S	63.6	8S3024-8A	53.0	16	8
42 x 24 x 96	8S4224-8S	72.8	8S4224-8A	62.2	24	8
56 x 24 x 96	8SH5624-8S	96.8	8SH5624-8A	86.2	32	8
30 INCH DEEP UNITS (2 DEEP STANDARD 16" DEEP ARCHIVAL BOX)						
30 x 30 x 60	5S3030-5S	52.0	5S3030-5A	49.4	20	5
42 x 30 x 60	5S4230-5S	58.8	5S4230-5A	56.2	30	5
56 x 30 x 60	5SH5630-5S	72.6	5SH5630-5A	70.0	40	5
30 x 30 x 72	6S3030-6S	61.2	6S3030-6A	57.8	24	6
42 x 30 x 72	6S4230-6S	68.8	6S4230-6A	65.4	36	6
56 x 30 x 72	6SH5630-6S	86.0	6SH5630-6A	82.6	48	6
30 x 30 x 84	7S3030-7S	70.0	7S3030-7A	66.2	28	7
42 x 30 x 84	7S4230-7S	78.4	7S4230-7A	74.6	42	7
56 x 30 x 84	7SH5630-7S	99.0	7SH5630-7A	95.2	56	7
30 x 30 x 96	8S3030-8S	79.2	8S3030-8A	74.6	32	8
42 x 30 x 96	8S4230-8S	88.4	8S4230-8A	83.8	48	8
56 x 30 x 96	8SH5630-8S	112.4	8SH5630-8A	107.8	64	8

NOTE: Contact factory when unit height to depth ratio exceeds 5 to 1. Anti-tip components may be required.

TIRE RACK STORAGE UNIT



RIVMAX™ tire storage racks are an economical solution for tire storage. Vertical storage of tires allows easy access. Units can easily be converted to a mezzanine/catwalk system to safely use all vertical space available within a building.



Heights to 22 feet • Width to 60 inches
Single and Double entry

- Completely boltless, assembles in minutes
- No cross bracing permits clear access to both sides of unit
- Units listed utilize heavy posts
- Beams are formed to accept round shape of tire
- Channel beams available for truck tires
- Other widths available
- All standard finishes are powder coated

TIRE RACK STORAGE UNIT

UNIT SIZE W x D x H	STARTER UNIT	ADDER UNIT	NO. OF TIERS	APPROX. TIRE CAP*
SINGLE ENTRY				
60 x 21 x 60	5T16021-2S	5T16021-2A	2	8 - 16
60 x 21 x 84	7T16021-3S	7T16021-3A	3	12 - 24
60 x 21 x 120	10T16021-4S	10T16021-4A	4	16 - 32
60 x 21 x 144	12T16021-5S	12T16021-5A	5	20 - 40
60 x 21 x 180	15T16021-6S	15T16021-6A	6	24 - 48

DOUBLE ENTRY				
60 x 42 x 60	5T26042-2S	5T26042-2A	2	16 - 32
60 x 42 x 84	7T26042-3S	7T26042-3A	3	24 - 48
60 x 42 x 120	10T26042-4S	10T26042-4A	4	32 - 64
60 x 42 x 144	12T26042-5S	12T26042-5A	5	40 - 80
60 x 42 x 180	15T26042-6S	15T26042-6A	6	48 - 96

* Per Unit

UNIT NUMBER DESCRIPTION

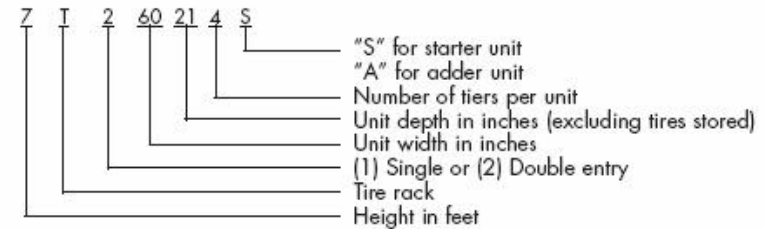

- * Capacities based on static loads. Consult factory for seismic applications.
- * Tire capacities are approximate.

APPAREL RACK HANG UNIT

APPAREL RACK HANG UNIT

UNIT SIZE W x D x H	STARTER	ADDER	ADDITIONAL HANG BAR LEVEL
SINGLE HANG BAR			
36 x 24 x 96	8A13624-2S	8A13624-2A	A13624
48 x 24 x 96	8A14824-2S	8A14824-2A	A14824
36 x 24 x 120	10A13624-3S	8A13624-3A	A13624
48 x 24 x 120	10A14824-3S	8A14824-3A	A14824
DOUBLE HANG BAR			
36 x 42 x 96	8A23642-2S	8A23642-2A	A23642
48 x 42 x 96	8A24842-2S	8A24842-2A	A24842
36 x 42 x 120	10A23642-3S	10A23642-3A	A23642
48 x 42 x 120	10A24842-3S	10A24842-3A	A24842

UNIT NUMBER DESCRIPTION

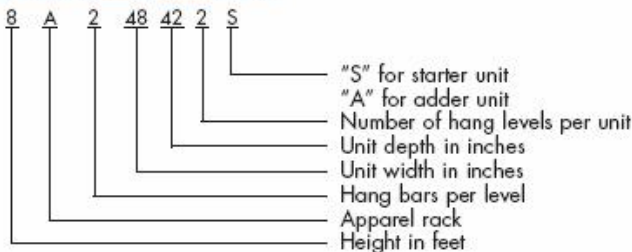

- * Capacities based on static loads. Consult factory for mobile or seismic applications.
- * Unit numbers listed do not include shelves, add a suffix "W" to unit number to include 5/8 inch particle board shelves. Top and bottom shelves are required for unit stability.

RIVMAX™ apparel racks are an economical solution for storage of garments. The rivet to dimple connection securely holds hang bar in position without nuts or bolts.



Heights to 22 feet • Width to 48 inches
Standard 24 and 42 inch depths

- Completely boltless, assembles in minutes
- No cross bracing permits clear access from all sides of unit
- Flexibility for one or more hang bars per level
- Units listed utilize standard posts
- Casters and base can be added to make mobile apparel rack
- Hang bars are black
- All standard finishes are powder coated
- Other depths available

UNIT GROWTH

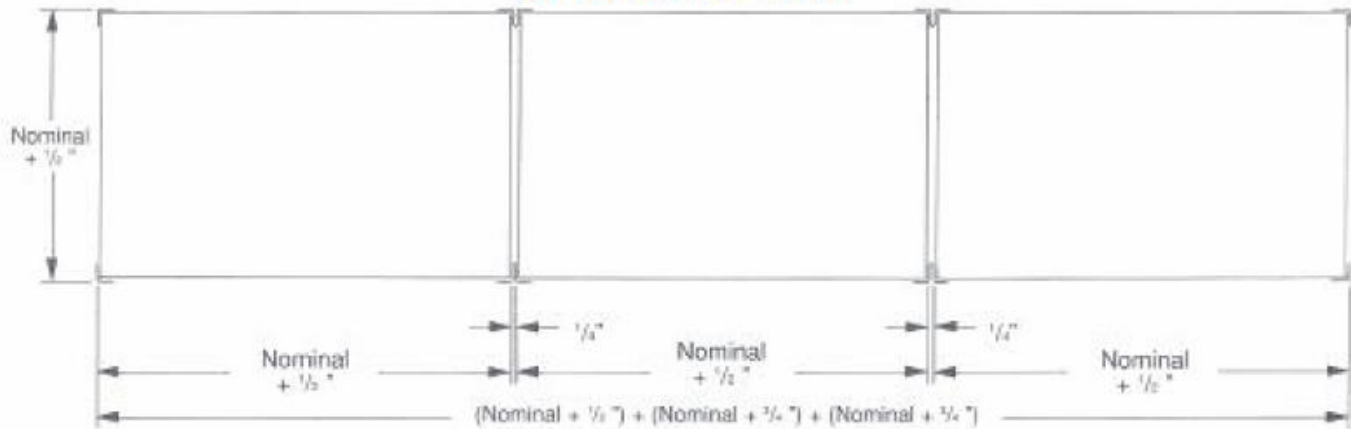

VERTICAL CLEAR OPENING

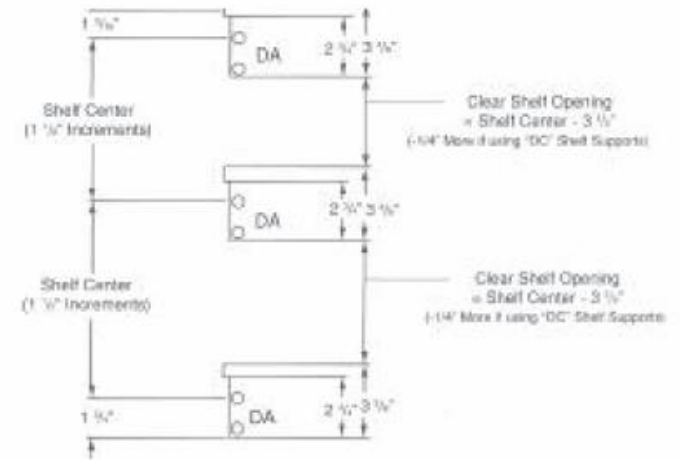
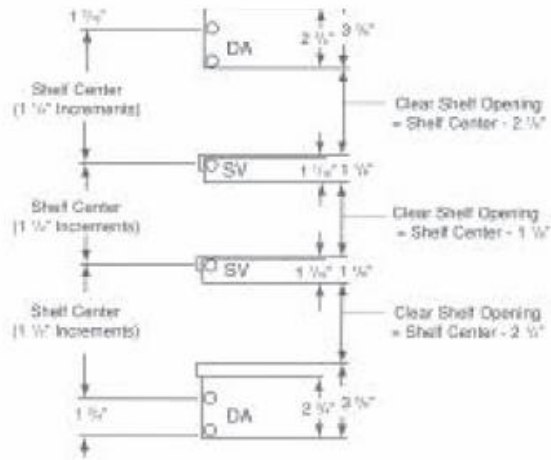

HORIZONTAL CLEAR OPENING

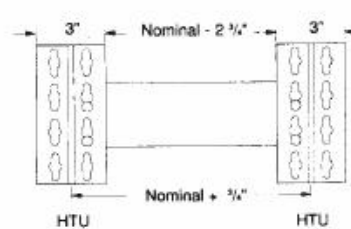
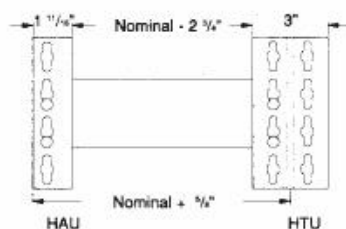
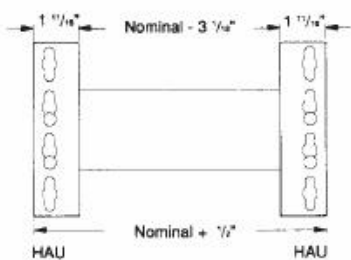
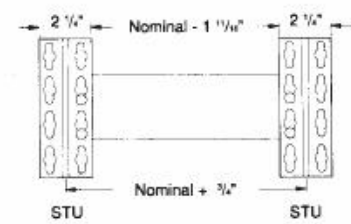
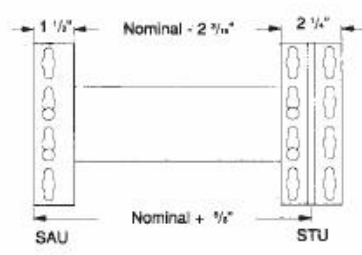
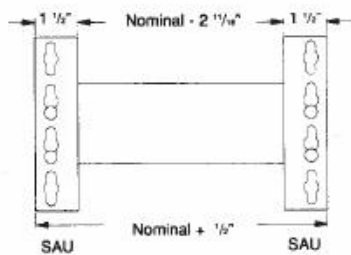

STANDARD ANGLE UPRIGHT

Unit Number	Size	Weight
SAU03	3'-0"	2.2#
SAU04	4'-0"	3.0
SAU05	5'-0"	3.7
SAU06	6'-0"	4.5
SAU07	7'-0"	5.2
SAU08	8'-0"	6.0
SAU09	9'-0"	6.8
SAU10	10'-0"	7.5
SAU12	12'-0"	8.9



1-1/2" w x 1-1/2" d

Used on extreme ends of rows or on starter units in standard shelving. Slots are on 1 1/2" vertical centers.



2-1/4" w x 1-1/2" d

STANDARD TEE UPRIGHT

Unit Number	Size	Weight
STU03	3'-0"	3.6#
STU04	4'-0"	4.9
STU05	5'-0"	6.1
STU06	6'-0"	7.3
STU07	7'-0"	8.5
STU08	8'-0"	9.7
STU09	9'-0"	10.9
STU10	10'-0"	12.1
STU12	12'-0"	14.6

Used as a common post on adder units in standard shelving. Slots are on 1-1/2" vertical centers.

HEAVY ANGLE UPRIGHT

Unit Number	Size	Weight
HAU03	3'-0"	3.0#
HAU04	4'-0"	4.0
HAU05	5'-0"	5.0
HAU06	6'-0"	5.9
HAU07	7'-0"	6.9
HAU08	8'-0"	7.9
HAU09	9'-0"	8.9
HAU10	10'-0"	9.9
HAU11	11'-0"	10.9
HAU12	12'-0"	11.9
HAU13	13'-0"	12.9
HAU14	14'-0"	13.9
HAU15	15'-0"	14.8
HAU15.5	15'-6"	15.3
HAU16	16'-0"	15.8
HAU18	18'-0"	17.8
HAU20	20'-0"	19.8
HAU22	22'-0"	21.8



1-11/16" w x 2-1/4" d

Used on extreme ends of rows or on starter units in heavy shelving. Slots are on 1-1/2" vertical centers.



3" w x 1-1/2" d

HEAVY TEE UPRIGHT

Unit Number	Size	Weight
HTU03	3'-0"	4.3#
HTU04	4'-0"	5.7
HTU05	5'-0"	7.1
HTU06	6'-0"	8.5
HTU07	7'-0"	9.9
HTU08	8'-0"	11.3
HTU09	9'-0"	12.7
HTU10	10'-0"	14.1
HTU11	11'-0"	15.5
HTU12	12'-0"	17.0
HTU13	13'-0"	18.4
HTU14	14'-0"	19.8
HTU15	15'-0"	21.2
HTU15.5	15'-6"	21.9
HTU16	16'-0"	22.6
HTU18	18'-0"	25.4
HTU20	20'-0"	28.2
HTU22	22'-0"	31.0

Used as a common post on adder units in heavy shelving. Slots are on 1-1/2" vertical centers.

UPRIGHT TIE

Unit Number	Size	Weight
UT	2" x 2"	0.2#

Used on join angle uprights side-to-side or back-to-back.

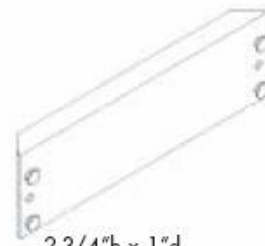

2-3/4" h x 1" d

(DA48 available with or without dimples. Components over 48" include dimples).

DOUBLE RIVET ANGLE

Unit Number	Size	Weight
DA12	1'-0"	0.9#
DA15	1'-3"	1.3
DA18	1'-6"	1.5
DA24	2'-0"	2.0
DA30	2'-6"	2.4
DA32	2'-8"	2.6
DA36	3'-0"	2.9
DA42	3'-6"	3.5
DA45	3'-9"	3.7
DA48	4'-0"	3.9
DA56	4'-8"	4.7
DA60	5'-0"	4.9
DA69	5'-9"	5.7
DA72	6'-0"	5.9
DA84	7'-0"	6.8
DA96	8'-0"	7.8

Used as shelf support and sway bracing.

DOUBLE RIVET ANGLE TIE

Unit Number	Size	Weight
DAT12	1'-0"	1.0#
DAT15	1'-3"	1.3
DAT18	1'-6"	1.5
DAT24	2'-0"	1.9
DAT30	2'-6"	2.4
DAT32	2'-8"	2.5
DAT36	3'-0"	2.8
DAT42	3'-6"	3.3
DAT45	3'-9"	3.7
DAT48	4'-0"	3.8



2-1/2" h x 1" d

Used to support center of shelf and to increase capacity of shelf. Attaches to dimple in "DA" and "DC". Can also be used as an aisle tie.

SINGLE RIVET VEE

Unit Number	Size	Weight
SV12	1'-0"	0.8#
SV18	1'-6"	1.0
SV24	2'-0"	1.3
SV30	2'-6"	1.5
SV36	3'-0"	1.7
SV42	3'-6"	1.9
SV48	4'-0"	2.2
SV60	5'-0"	2.5
HEAVY GAUGE SVH48	4'-0"	3.3



1-1/16" h x 7/8" d

Used as low profile shelf support.

LOW PROFILE CENTER SUPPORT

Unit Number	Size	Weight
LPCS24	2'-0"	1.0#
LPCS30	2'-6"	1.4
LPCS36	3'-0"	1.7
LPCS42	3'-6"	2.0
LPCS48	4'-0"	2.3

Used with "SV" to support center of shelf (does not increase capacity of "SV").

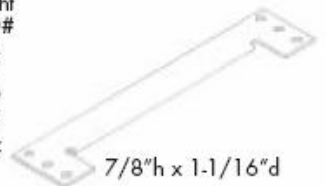

7/8" h x 1-1/16" d



2-1/16" h

DOUBLE RIVET FLAT

Unit Number	Size	Weight
DF12	1'-0"	0.5#
DF15	1'-3"	0.6
DF18	1'-6"	0.8
DF24	2'-0"	1.0

Used as sway bracing in lighter capacity applications.

DOUBLE RIVET VEE

Unit Number	Size	Weight
DV12	1'-0"	0.8#
DV18	1'-6"	1.0
DV24	2'-0"	1.3
DV30	2'-6"	1.5
DV36	3'-0"	1.7
DV42	3'-6"	1.9
DV48	4'-0"	2.2
DV60	5'-0"	2.5

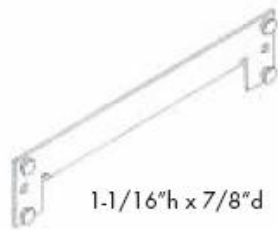

1-1/16"h x 7/8"d

Used as a low profile shelf support where sway bracing is needed.



UNIVERSAL CLIP

Unit Number	Size	Weight
UC	1-1/2 x 2-3/16 x 2	0.2#

Used in a variety of anchoring and attached applications.

DOUBLE RIVET CHANNEL

Unit Number	Size	Weight
DC48	4'-0"	5.5#
DC60	5'-0"	6.7
DC69	5'-9"	7.7
DC72	6'-0"	8.0
DC84	7'-0"	9.2
DC96	8'-0"	10.6

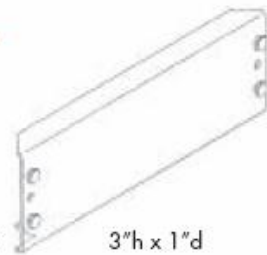

3"h x 1"d

Used as a shelf support to carry heavier loads

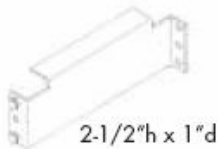

2-1/2"h x 1"d

DOUBLE RIVET WALL TIE

Unit Number	Size	Weight
DWT09	0'-9"	0.8#

Used to tie upright to wall. Normally used in tire racks.

DOUBLE RIVET ANGLE AISLE TIE

Unit Number	Size	Weight
DAAT18	1'-6"	1.6#
DAAT30	2'-6"	2.5
DAAT36	3'-0"	2.9
DAAT42	3'-6"	3.4
DAAT48	4'-0"	3.9



2-1/2"h x 1"d

Used as an aisle spacer/tie.

DOUBLE RIVET NARROW CHANNEL

Unit Number	Size	Weight
DNC48	4'-0"	3.9#
DNC60	5'-0"	4.9
DNC69	5'-9"	5.7
DNC72	6'-0"	5.9



1-3/4"h x 1"d

Used as shelf support where shelf capacity and minimum vertical shelf height is required.

NARROW CHANNEL TIE

Unit Number	Size	Weight
NCT15	1'-3"	0.9#
NCT30	2'-6"	1.8
NCT36	3'-0"	2.2
NCT42	3'-6"	2.6
NCT48	4'-0"	2.9

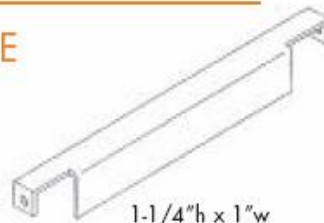

1-1/4"h x 1"w

Used with "DNC" to support center of shelf (does not increase capacity of "DNC").

DOUBLE RIVET TIRE ANGLE

Unit Number	Size	Weight
DTA36	3'-0"	2.9#
DTA48	4'-0"	3.9
DTA60	5'-0"	4.9



2-3/4"h x 1"d

Used to support tires in tire rack.

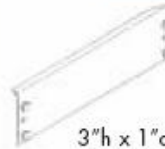

3"h x 1"d

DOUBLE RIVET TIRE CHANNEL

Unit Number	Size	Weight
DTC60	5'-0"	6.9#

Used to support truck tires in tire rack.

DOUBLE RIVET HANG BAR SUPPORT

Unit Number	Size	Weight
DAHB18-1	1'-6"	1.5#
DAHB24-1	2'-0"	2.0
DAHB24-2	2'-0"	2.0
DAHB30-1	2'-6"	2.4
DAHB36-1	3'-0"	2.9
DAHB42-2	3'-6"	3.5
DAHB48-2	4'-0"	3.9



2-3/4"h x 1"d

Used as a hang bar support and as sway bracing in apparel racks. Suffix on part numbers identifies number of dimples for hang bar attachment.

DOUBLE RIVET HANG BARS

Unit Number	Size	Weight
DHB36BK	3'-0"	2.8#
DHB48BK	4'-0"	3.7

Used as a hang bar in apparel racks. Made of 12 gauge steel. Standard color is black.

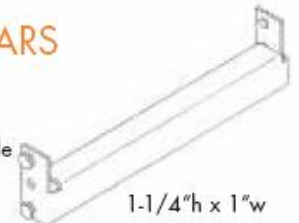

1-1/4"h x 1"w

DOUBLE RIVET VEE HEAVY

Unit Number	Size	Weight
DVH36BK	3'-0"	2.8#
DVH48BK	4'-0"	3.7

Used as a hang bar. Attaches to uprights to hang items on the face of the unit. Made of 12 gauge steel. Standard color is black.

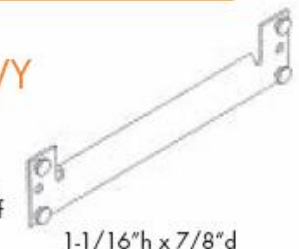

1-1/16"h x 7/8"d

SINGLE RIVET ANGLES

Unit Number	Size	Weight
SA12	1'-0"	0.8#
SA18	1'-6"	1.0
SA24	2'-0"	1.3
SA30	2'-6"	1.5
SA36	3'-0"	1.7
SA42	3'-6"	1.9
SA48	4'-0"	2.2



1-1/16"h x 1"d

Used as a low profile shelf support. Shelf rest on top of flange. Flange lines up with "DA" flange and may be used on same shelf level as "DA".



INDUSTRIAL PARTICLE BOARD

RIVMAX™ wood shelving is made of 5/8 inch thick Industrial particle board (45lbs density).

W x D	PART NUMBER	TOTAL WGT	W x D	PART NUMBER	TOTAL WGT
36 x 12	PB3612	7.5	60 x 12	PB6012	12.5
36 x 15	PB3615	9.4	60 x 18	PB6018	18.8
36 x 18	PB3618	11.3	60 x 24	PB6024	25.0
36 x 24	PB3624	15.0	60 x 30	PB6030	31.3
36 x 30	PB3630	18.8	60 x 36	PB6036	37.5
36 x 36	PB3636	22.5	60 x 42	PB6042	43.8
36 x 42	PB3642	26.3	60 x 48	PB6048	50.0
36 x 48	PB3648	30.0			
			69 x 15	PB6915	18.0
42 x 12	PB4212	8.8	69 x 24	PB6924	28.8
42 x 15	PB4215	10.9	69 x 30	PB6930	35.9
42 x 18	PB4218	13.1	69 x 32	PB6932	38.3
42 x 24	PB4224	17.5	69 x 48	PB6948	57.5
42 x 30	PB4230	21.9			
42 x 32	PB4232	23.3	72 x 12	PB7212	15.0
42 x 36	PB4236	26.3	72 x 18	PB7218	22.5
42 x 42	PB4242	30.6	72 x 24	PB7224	30.0
42 x 48	PB4248	35.0	72 x 30	PB7230	37.5
			72 x 36	PB7236	45.0
48 x 12	PB4812	10.0	72 x 42	PB7242	52.5
48 x 15	PB4815	12.5	72 x 48	PB7248	60.0
48 x 18	PB4818	15.0			
48 x 24	PB4824	20.0	96 x 12	PB9612	20.0
48 x 30	PB4830	25.0	96 x 18	PB9618	30.0
48 x 36	PB4836	30.0	96 x 24	PB9624	40.0
48 x 42	PB4842	35.0	96 x 30	PB9630	50.0
48 x 48	PB4848	40.0	96 x 36	PB9636	60.0
			96 x 42	PB9642	70.0
			96 x 48	PB9648	80.0

GALVANIZED WIRE DECKS

RIVMAX™ galvanized wire decks (4 gauge) are designed for Rivet Type Shelving. Constructed with 2" x 4" Mesh with Wrap Around Wire.

D x L	PART NUMBER	TOTAL WGT
12 x 36	PHS1236FLAT	3.9
12 x 48	PHS1248FLAT	5.2
15 x 69	PHS1569FLAT	9.3
18 x 36	PHS1836FLAT	5.9
18 x 48	PHS1848FLAT	7.7
18 x 60	PHS1860FLAT	9.7
18 x 72	PHS1872FLAT	11.5
24 x 36	PHS2436FLAT	7.4
24 x 48	PHS2448FLAT	9.8
24 x 60	PHS2460FLAT	12.1
24 x 72	PHS2472FLAT	14.5
30 x 69	PHS3069FLAT	17.7
30 x 72	PHS3072FLAT	18.3
32 x 69	PHS3269FLAT	18.5
36 x 36	PHS3636FLAT	10.9
36 x 48	PHS3648FLAT	14.4
36 x 72	PHS3672FLAT	21.4
48 x 48	PHS4848FLAT	19.1
48 x 72	PHS4872FLAT	28.2

PROTECT YOUR INVESTMENT



RIVMAX™ Post Protectors protect:

- Shelving
- Stairways
- Handrails
- Equipment
- Racking
- Columns

from pallet jack or forklift damage.

- For nearly any type of rack upright
- 1/4 inch plate steel construction
- Yellow powder coated finish standard
- F.O.B. - Jackson, MI
- Anchoring hardware available

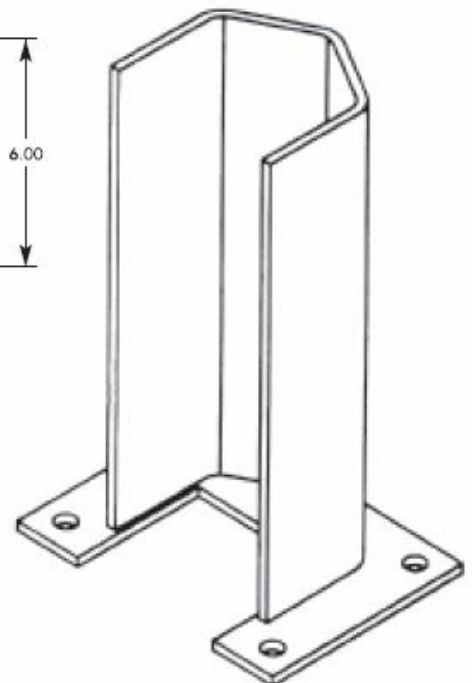
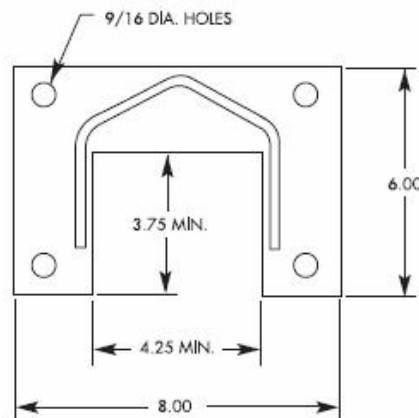

POST PROTECTORS

Unit Number	Height	Weight
PP12YW	12"	11.4#
PP18YW	18"	15.5
PP24YW	24"	20.3
PP36YW	36"	30.0

RIVMAX™

THE BOLTLESS SHELVING SYSTEM

RIVMAX is comprised of dedicated people who are quality conscious and adaptive to customers needs. All of our products are **100% made in the USA**, processed and powdercoated in compliance with the **ISO 9001:2000** standard.

STANDARD COLORS



GREY #HB1421

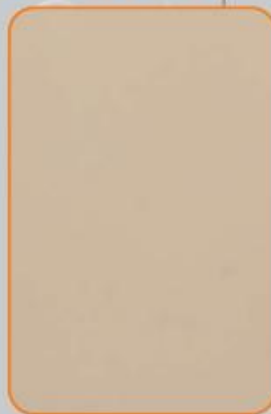

PUTTY #PT1688

CUSTOM COLORS*



BLACK (texture) #BTD418



OCEAN BLUE #HB3231

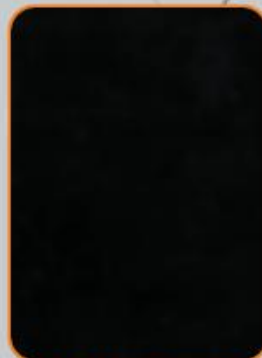

COAL BLACK #BK2498

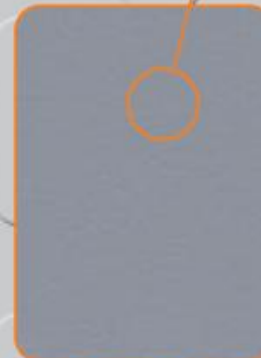

GREY (texture) #GT8844

*contact your sales representative for custom color pricing.